

Claybrook.

MIDTOWN SHOWER

Fitting Instructions for Midtown 2/3 Way Thermostatic Concealed Shower with Levers

Chrome and Matt Black finish



Istruzioni di montaggio



Installation Instructions



Instruction de montage

Miscelatore termostatico COAX con deviatore

Thermostatic COAX mixer with diverter

Mélangeur COAX thermostatique avec déviateur



Grazie per aver scelto Midtown 2/3 way thermostatic concealed shower with levers. Perché il Suo rubinetto funzioni correttamente e possa durare nel tempo, occorre che vengano rispettate le procedure di installazione ed manutenzione illustrate in questo opuscolo.

Thank you for selecting Midtown 2/3 way thermostatic concealed shower with levers. In order to allow a proper functioning of your fitting and a long-lasting reliability, you must carefully observe our care and installation instructions described in this brochure.

Nous vous remercions d'avoir choisi Midtown 2/3 way thermostatic concealed shower with levers. Afin que cet appareil fonctionne d'une manière correcte et puisse durer longtemps, il convient de respecter les modalités d'installation et d'entretien indiquées dans cette notice.

Preliminari

Prima di procedere all'installazione è necessario pulire accuratamente le tubature per eliminare eventuali detriti in esse presenti

Preliminary information

Before starting with the installation it is necessary to clean the pipes carefully in order to eliminate any deposit which may be found inside them.

Preliminaires

Avant de monter les mitigeur, il faut bien nettoyer les tuyaux pour éliminer toutes les impuretés à l'intérieur.

If you require any further assistance regarding specification data and technical advice please contact us at enquiries@claybrookstudio.co.uk



MIDTOWN SHOWER

Fitting Instructions for Midtown 2 Way Thermostatic Concealed Shower with Levers

2 way concealed shower

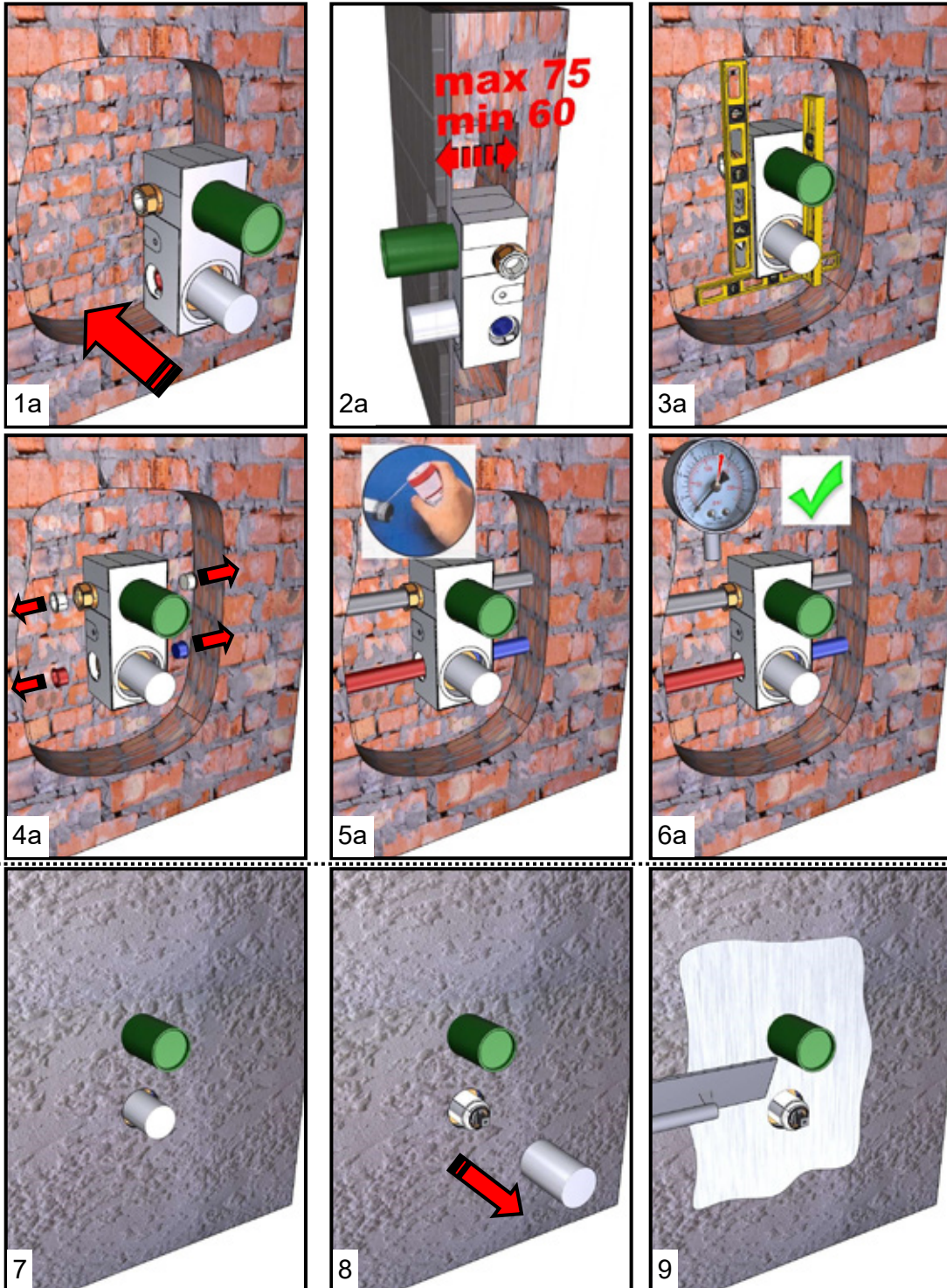

MIDTOWN SHOWER

Fitting Instructions for Midtown 3 Way Thermostatic Concealed Shower with Levers

3 way concealed shower

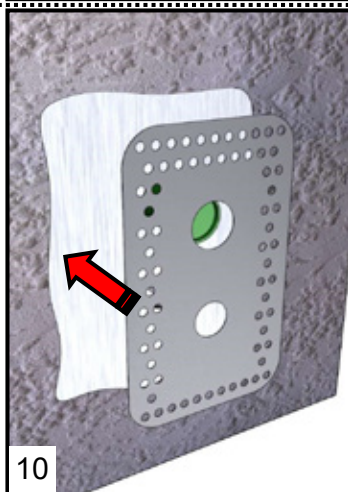
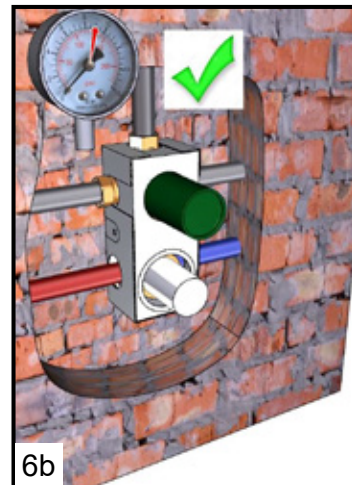
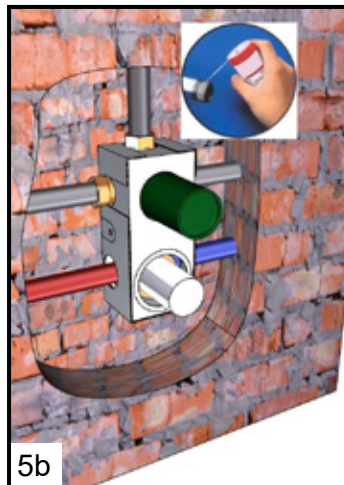
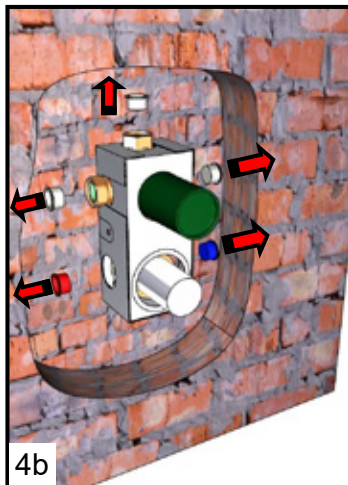
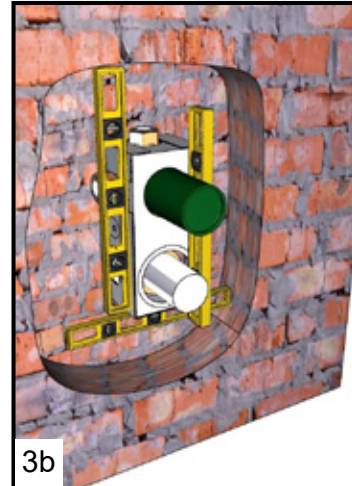
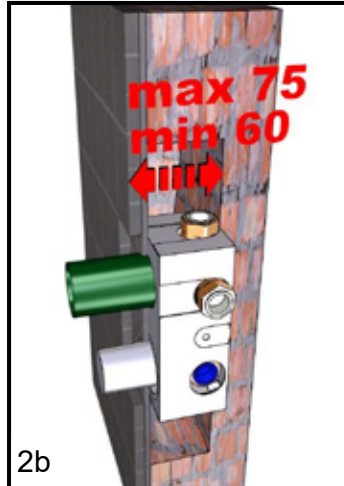

MIDTOWN SHOWER

Fitting Instructions for Midtown 2/3 Way Thermostatic Concealed Shower with Levers

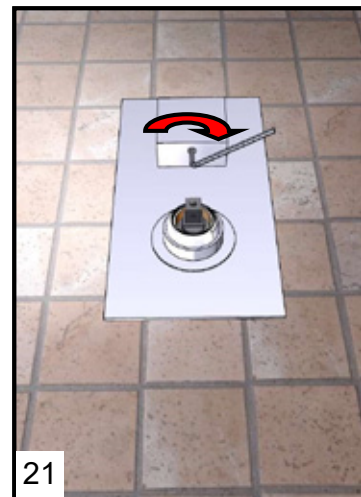
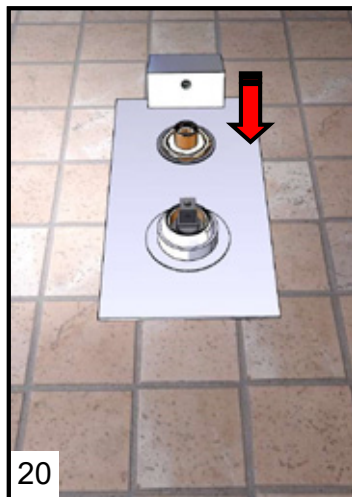
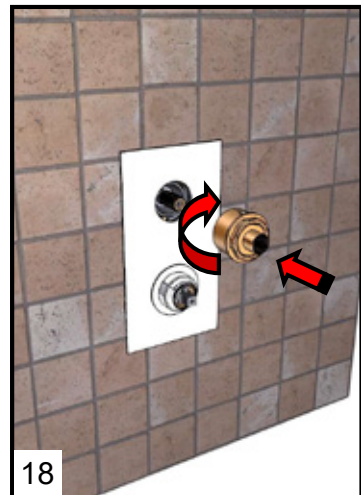
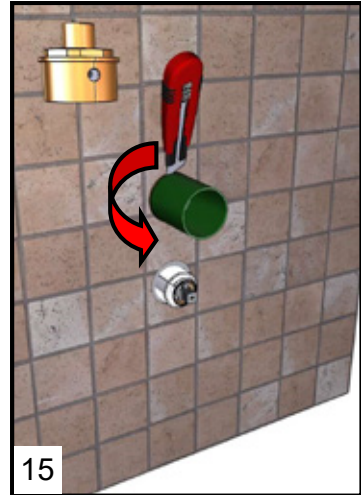
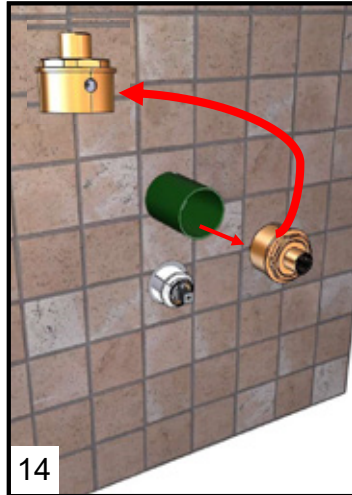
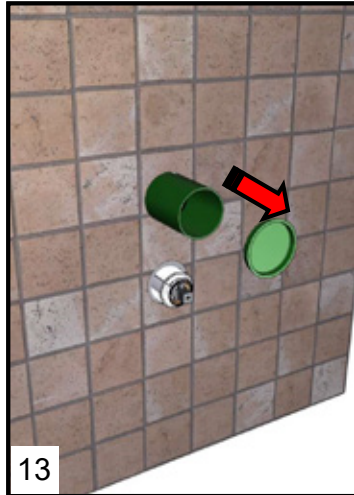

Claybrook.

MIDTOWN SHOWER

Fitting Instructions for Midtown 2/3 Way Thermostatic Concealed Shower with Levers

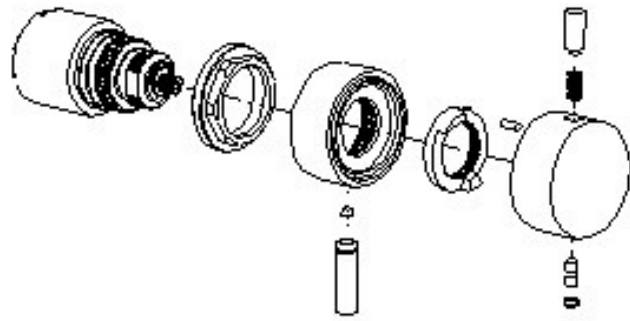
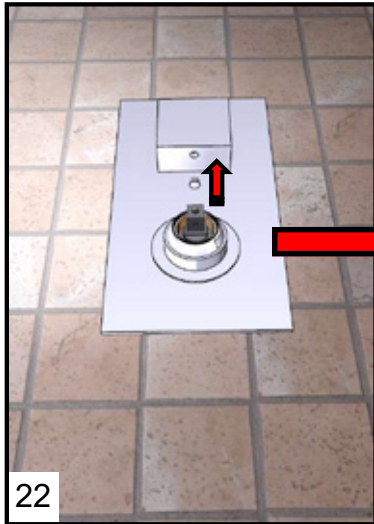

Funzionamento - Use - Fonctionnement

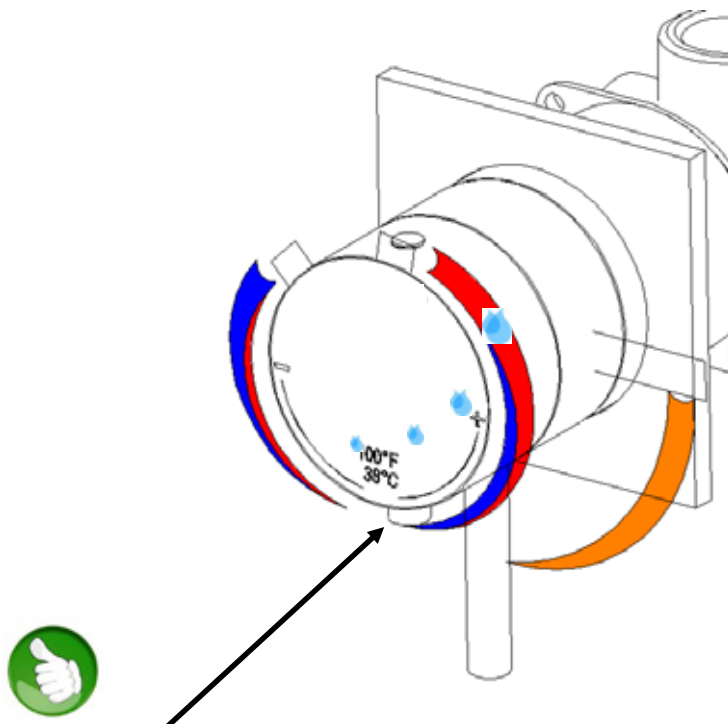

Bloccaggio anti scottatura 38°C premere per sbloccare
NO heating system 100F push to unlock

If you require any further assistance regarding specification data and technical advice please contact us at enquiries@claybrookstudio.co.uk



MIDTOWN SHOWER

Fitting Instructions for Midtown 2/3 Way Thermostatic Concealed Shower with Levers

Montaggio maniglia portata - Installation handle flow - Montage de la manette de flux

Inserire la maniglia di portata (3) nella cartuccia assicurandosi che la leva (1) sia perfettamente verticale verso il basso, inserire l'articolo (4) rispettando le Fig. 2 e 3

Insert the flow handle (3) in the cartridge making sure that the lever (1) is perfectly vertical downward, insert the article (4) respecting the Fig. 2 and 3

Insérez le flux poignée (3) dans la cartouche en vous assurant que le levier (1) est suspendu verticalement vers le bas, monter l'article (4) en respectant la figure 2 et 3

Inserire la maniglia della temperatura (5) mantenendo il segno celeste riportato sull'asta della cartuccia nella posizione in cui si trova, anche se non allineato con il resto, tirare il grano (6) ed inserire il tappo di copertura (7).

Insert the temperature handle (5) to keep the light blue sign shown on the rod of the cartridge in the position in which it is located, even if not aligned with the rest, tight the two screws (6) with a 3mm Allen wrench and insert the plug cover (7).

Insérez la poignée de la température (5) regarder le signe céleste maintenir le signe céleste représenté sur la tige de la cartouche dans la position dans laquelle il se trouve, même si elle n'est pas alignée avec les autres, tirez les deux vis (6) avec une clé Allen de 3 mm et insérez le couvercle de la prise (7).

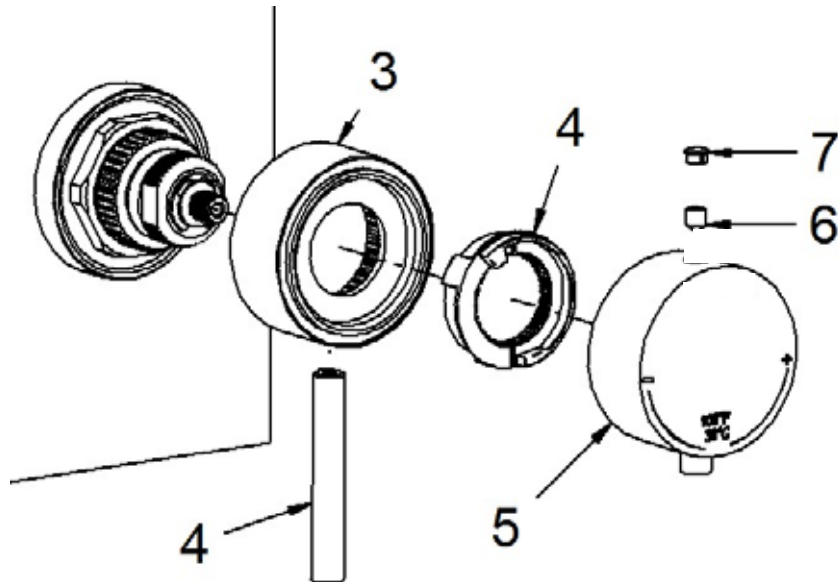

Fig. 2



Fig. 3

